

# IRP10525DS10 5U DIN Rail Double Panel

## Included in this package

(1) RCB1118BK Main Panel ◆  
and (1) Din Rail.

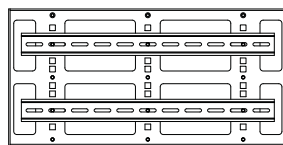

(18) M4 x 8 Screws



(2) RCB1118BK Ear Bracket ❖

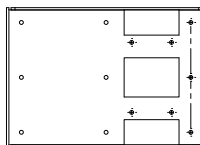

(4) #10-32 x 5/8 Rack  
Screws



(2) PVC Wire Duct◆

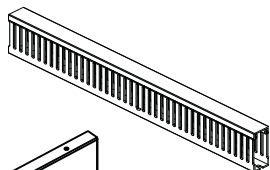

(4) #12-24 x 5/8 Rack  
Screws



(1) 5U Blank Panel

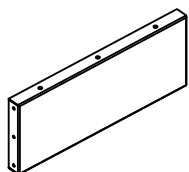

## Installation Steps

Step 1. Place Main Panel ◆ on a flat surface. Place (2) PVC Wire duct ◆ on top with top cover removed.

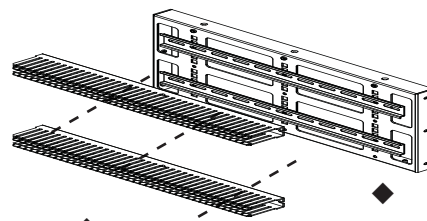

Figure 1

Step 2. Align wire duct's ◆ inside open slots with 3 screw holes on top and bottom edge of Main Panel ◆. Secure them with M4x8 screws. (Figure 1)

Step 3. Place ear bracket ❖ on right and left side of main panel ◆. You can align your main panel ◆ to Front Position, Center Position or Rear Position screw holes on ear brackets (Figure 3) depends on your application need. Rear Position is the standard mounting position.

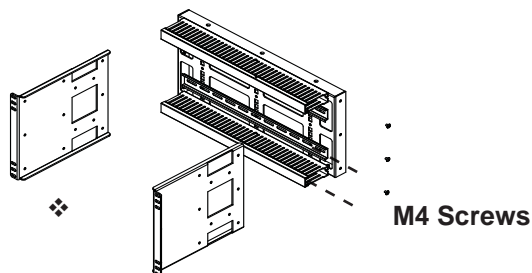

Figure 2

Step 4. Secure both side ear bracket ❖ with (3)M4x8 screw for each side to complete installation.

Step 5. For blank panle installation follow the same installation instruction for DIN Rail panel from Step 2.

Step 6. Readjust Din rail position up or down according to your din rail equipment's space requirement. You will need RSN1035-K1 Cage Nut Kit (Not included) for different position mounting.

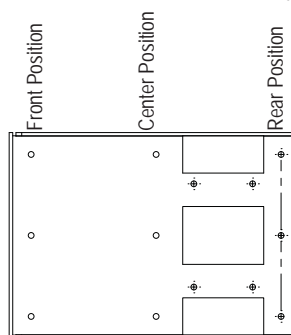

Figure 3

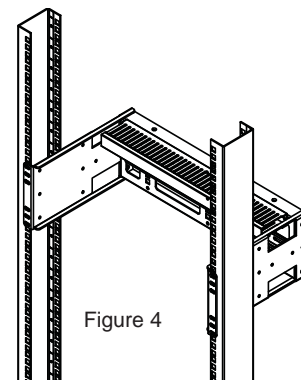

Figure 4